



LK162-12

User Manual



Table of Contents

1. Introduction.....	5
1.1 What it Does	5
1.2 What it Does Not Do	5
1.3 Keypad Interface.....	5
1.4 Setup for Testing.....	5
1.5 Trying Out your LK162-12.....	6
1.6 Trying out a Keypad.....	7
1.6.1 Here's what to do:.....	7
1.7 Manual Override.....	8
1.8 Memory Chip Lockdown.....	7
2. Connections.....	10
2.1 Connector Pinout	10
2.1.1 Power and I ² C Connections	9
2.1.1.1 Five VoltModules.....	10
2.1.1.2 Wide Voltage Range Modules.....	10
2.1.2 DB-9 Power.....	10
2.1.3 RS-232 Communications.....	11
2.1.4 I ² C Communications.....	11
2.1.5 Alternate Serial Connection.....	12
2.1.6 TTL Communications.....	13
2.1.7 I2C Communications.....	13
2.2 General Purpose Outputs	15
3. Displaying Text.....	17
3.1 General.....	17
3.2 The Built-In Character Font	17
3.3 Writing Text to the Display	18
3.4 Text Commands	18
3.4.1 Auto line wrap on (254 67)(R).....	17
3.4.2 Auto line wrap off (254 68)(R).....	17
3.4.3 Auto scroll on (254 81)(R).....	17
3.4.4 Auto scroll off (254 82)(R).....	17
3.4.5 Set cursor position (254 71 [column][row]).....	17
3.4.6 Send cursor home (254 72).....	17
3.4.7 Turn on underline cursor (254 74)(R).....	18
3.4.8 Turn off underline cursor (254 75)(R).....	18
3.4.9 Turn on block (blinking) cursor (254 83)(R).....	18
3.4.10 Turn off block (blinking) cursor (254 84)(R).....	18
3.4.11 Cursor left (254 76).....	18
3.4.12 Cursor right (254 77).....	18
4. Keypad Interface.....	20
4.1 General.....	20
4.2 Connections	20
4.3 I ² C Interface.....	17
4.4 RS-232 Interface.....	21

4.5 Keypad Commands.....	21
4.5.1 Auto repeat mode on (254 126 [mode]) (R).....	20
4.5.2 Auto repeat mode off (254 96) (R).....	21
4.5.3 Auto transmit keypresses on (254 65) (R).....	21
4.5.4 Auto transmit keypresses off (254 79) (R).....	21
4.5.5 Clear key buffer (254 69).....	21
4.5.6 Poll keypad (254 38).....	22
4.5.7 Set debounce time (254 85 [time]) (R).....	21
5. Bar Graphs and Special Characters.....	24
5.1 Command List.....	24
5.1.1 Initialize wide vertical bar graph (254 118).....	24
5.1.2 Initialize narrow vertical bar graph (154 115).....	24
5.1.3 Draw vertical bar graph (254 61 [column] [height]).....	24
5.1.4 Initialize horizontal bar graph (254 104).....	24
5.1.5 Draw horizontal bar graph (254 124 [column] [row] [dir] [length]).....	24
5.1.6 Define custom character (254 78 [c] [8 bytes]).....	24
6. Miscellaneous Commands.....	27
6.1 Command List.....	26
6.1.1 Remember.....	27
6.1.2 Clear display (254 88).....	27
6.1.3 Set contrast (254 80 [contrast]).....	27
6.1.4 Set contrast and save (254 145 [contrast]).....	28
6.1.5 Backlight on (254 66 [minutes]) (R).....	28
6.1.6 Backlight off (254 70) (R).....	28
6.1.7 Load startup screen (254 64 [32 characters]).....	28
6.1.8 Set backlight brightness (254 153 [brightness]).....	28
6.1.9 Set backlight brightness and save (254 154 [brightness]).....	28
6.1.10 General purpose output off (254 86 [gpo #]).....	28
6.1.11 General purpose output on (254 87 [gpo #]).....	28
6.1.12 Set I ² C address 254 51 [address].....	28
6.1.13 Read module type (254 55).....	30
6.1.14 Set RS232 port speed (254 57 [speed]).....	30
6.1.15 Set Serial Number (254 52 [byte1] [byte2]).....	30
6.1.16 Read Serial Number (254 53).....	30
6.1.17 Read Version Number (254 54).....	31
6.2 Flow Control.....	31
6.2.1 Enter Flow Control Mode (254 58 [full][empty]).....	31
6.2.2 Exit Flow Control Mode (254 59).....	31
6.2.3 GPO or Keypad Mode (254 37 [mode]).....	31
7. Appendix: Command Summary.....	32
7.1 General.....	32
7.2 Issuing Commands.....	32
7.3 On Numbers.....	32
7.3.1 ASCII Characters.....	33
7.4 Text Commands.....	33
7.5 Keypad Interface Commands.....	34

7.6 Bar Graphs and Special Characters	36
7.7 Miscellaneous Commands	37
8. Appendix: Specifications and Options.....	39
8.1 Specifications.....	39
8.2 Options	40
9. Appendix: Glossary.....	41

Revisions

1. Version 3.0, March 11, 2003

- a. New PCB rev 2.2
- b. Added RS232 and I²C communication through 4 pin SIP header (power header)
- c. TTL option added
- d. Memory Chip lock down option added
- e. Variable Brightness backlight added

1. Introduction

Your LK162-12 has the following features:

- ✂ 16 column by 2 line text display
- ✂ built-in font with provision for up to 8 user-defined characters
- ✂ Speeds from 1200 bps to a lightning fast 19.2 Kbps over RS232
- ✂ Use our "Remember" functions to save settings
- ✂ Communicate over I²C or RS232 (with software controlled speed)
- ✂ Use up to 127 modules on the same 2-wire I²C interface
- ✂ Fully buffered so that no delays in transmission are ever necessary
- ✂ Add your own Splash/Start-up screen
- ✂ Software controlled contrast
- ✂ Backlight with configurable time-out setting up to 180 minutes
- ✂ Use up to a 12 key keypad with a 10 key buffer.
- ✂ Seven general purpose outputs for a variety of applications
- ✂ Horizontal or Vertical bar graphs
- ✂ Variable power options, +5V or +9V to +15V
- ✂ Extended temperature option.

1.1 What it Does

The LK162-12 is designed as the display unit for an associated controller. The controller may be anything from a single board, special purpose microcontroller to a PC, depending on the application. This controller is responsible for what you see on the screen of the LK162-12.

The LK162-12 provides a simple command structure to allow text and bar graphs to be displayed on the screen. Text fonts are built in, and use standard ASCII mapping. Provision is made for up to 8 user-defined characters.

The screen is backlit for low-light situations. Backlighting may be turned on or off under program control. Contrast is adjustable to compensate for differing lighting conditions and viewing angles.

General purpose outputs allow the controller to switch up to seven electronic or electro-mechanical devices by issuing commands to the display unit. These can be used for controlling LEDs, relays, etc.

1.2 What it Does Not Do

The LK162-12 does not include bitmap graphics capability, except that permitted by defining special characters.

1.3 Keypad Interface

The keypad interface takes row/column input and converts it to ASCII characters, which are delivered out the RS-232 or I²C port to the associated controller. Note that the keypad is **not** used to directly control any aspect of the operation of the LK162-12, which acts simply as a matrix to serial converter. If you want to use the keypad to control the LK162-12 display you must program your controller accordingly.

1.4 Setup for Testing

Before setting up your application you may want to try out the LK162-12. This is easily done with a PC. Here's what you'll need:

- ✂ A power cable with a 4 pin connector (same connector as used to connect 3.5 inch floppy drive). Do not connect the LK162-12 to an unmodified spare power connector in a PC. To modify such a cable see section 2.1.1.
- ✂ A 5 V power supply.
- ✂ a PC with a spare RS-232 port (COM1 or COM2).
- ✂ A 9 or 25 pin RS-232 serial cable. If you use a 25 conductor cable you'll also need a 9 to 25 pin adapter.

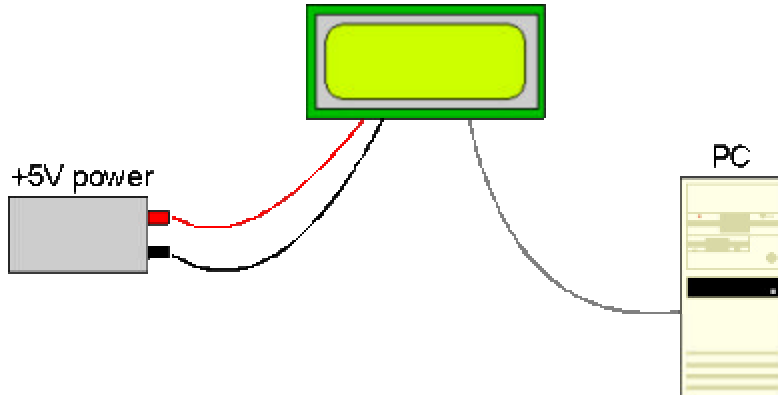

Figure 1-1 Connections for Testing

1. Refer to the diagram above and Figure 2-1 for the following steps.
2. Wire the connector to the power supply. On most connectors the RED lead will go to +5V and the BLACK lead to GND. See Section 2.1.1 for details. **Note: The manufacturer's warranty is void if the unit is subjected to over-voltage or reversed polarity.**
3. Connect the LK162-12 to the PC using the serial cable and adapter if required. **Make sure the RS-232 cable includes the required ground lead. There must be no voltage differential between the RS-232 ground and the power supply ground.**
4. Connect the power connector, making sure that the +5V goes to V+ as shown in Figure 2-2. Turn on the power: the LCD backlight should come on.

Now you're ready to try it out.

1.5 Trying Out your LK162-12

The unit is connected to power and the PC and the backlight is on. You should see a blinking cursor in the top left corner of the display. You're ready to make sure it's working properly. To experiment with typing text, run a PC program, such as Display Tuner or AlphaDemo. Make sure it's configured to use the correct port. Set the baud rate to 19,200.

If you want to exercise some of the other features of the LCD2041 you'll need to write a program (in any convenient language such as Basic or C) to issue the required command strings. Most terminal programs are unable to issue the 0xFE character needed as a command prefix. You probably won't need to do this at the initial testing stage.

If you've reached this point and operation is normal, you can be confident that your LCD2041 works properly.

1.6 Trying out a Keypad

Since a number of different keypad types can be connected to the LK162-12, the results you get may be a little unpredictable. At this point all we need to do is make sure that your keypad and interface work, and possibly generate an ASCII map for your programming needs.

The keypad interface on the LK162-12 converts a row/column connection to an ASCII character. By default, a keypress is transmitted as serial data immediately. Keypad buffering can be selected using the appropriate commands.

1.6.1 Here's what to do:

1. Your PC should be running a terminal program, such as Hyperterm (make sure hardware flow control is turned off).
2. With the LK162-12 connected to the PC, plug in your keypad. If your connector has fewer pins than the one on the LK162-12, center it as well as possible.

Note 1: The keypad connector must be wired with columns on one side and rows on the other side of the center of the connector. If your keypad isn't wired this way you will need to make an adapter or rewire the connector to meet this requirement.

Note 2: The connector is reversible. Reversing the connector will not damage the keypad or the LK162-12, but it will change the ASCII character map.

3. Press a key on the keypad. An upper case ASCII character (A-Y) should appear on the PC screen. Different keys should generate different characters.

If you want to experiment, reverse the connector and see if it generates a more logical set of characters. Ultimately, the program in your controller will have to "map" these characters to the ones marked on the keypad, which will likely be different.

1.7 Manual Override

Manual override should only be required in one instance. If for some reason the module is set at a baud rate which cannot be produced by the host system and all communication to the display is lost, then the user should follow this simple procedure:

1. Turn off the display
2. Put a jumper on pins 3 and 4 of the keypad connector (R3 and C1).
3. Power up the display. The baud rate is now set to 19,200.
4. Remove the jumper and change the RS-232 port settings to the desired baud rate.
5. Turn off the display.
6. Power up the display.

Refer to the “Set RS-232 Port Speed” command (section 6.1.14) for acceptable baud rates.

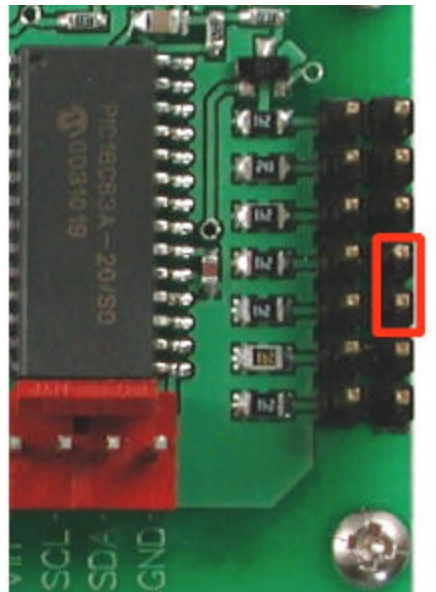

Place jumper on the above pins

1.8 Memory Chip Lock Down

The LK162-12 uses a memory chip to store speed, startup screen contrast, I²C setting and other settings. When everything has been changed to the wanted settings and the unit will be in a finished product or in the field, locking down the memory chip so no settings can be changed might be desirable. This is only to be done by knowledgeable people. Any damage to the display by this procedure resulting from user error will no be covered under warranty.

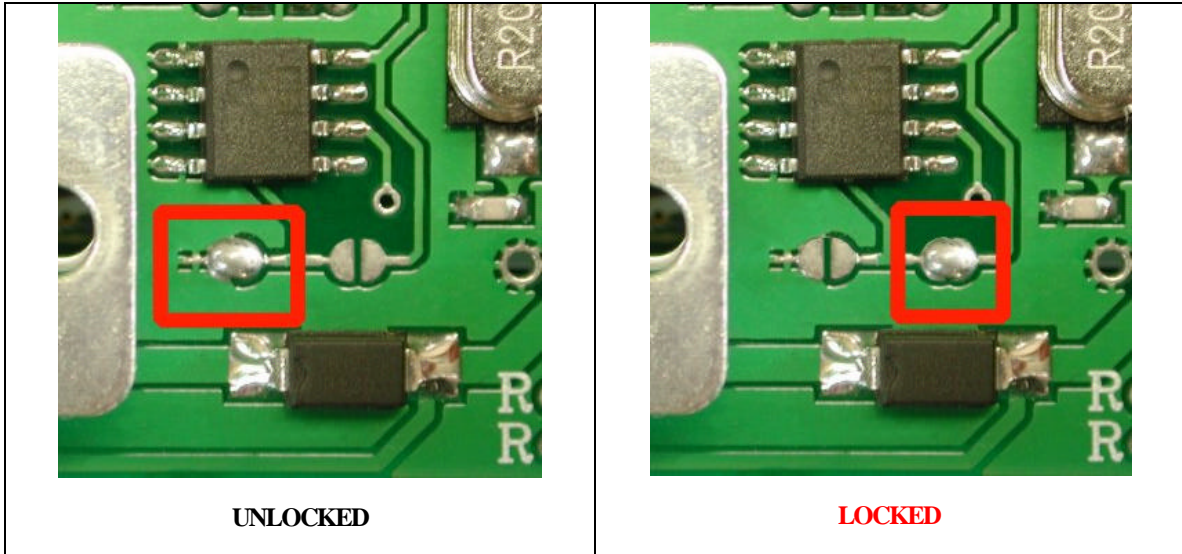

To lock down the memory chip, solder the jumper as shown in the LOCKED picture above. This will lock down the memory chip, not allowing anything to be changed inside it until the jumpers are restored to their original position.

2. Connections

2.1 Connector Pinout

Refer to the diagram below for this chapter.

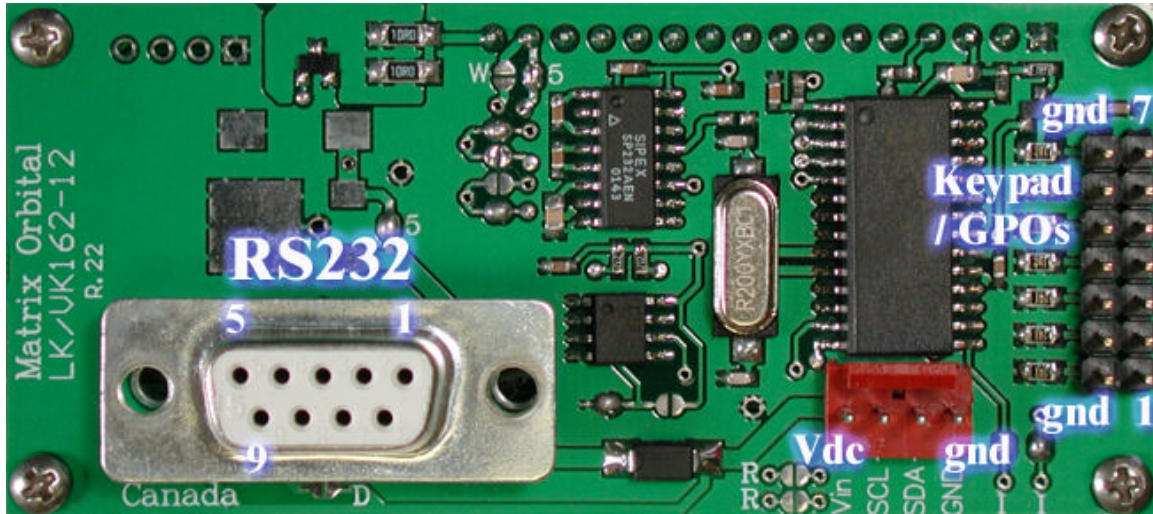

Figure 2-1 Electrical Connections

The LK162-12 has four connectors:

<u>Connector</u>	<u>Function</u>
14 pin dual header	General purpose outputs or Keypad (2x7) (see section 2.2)
4 pin	power (Vdc) and I ² C/RS232 communications (see section 2.1.1)
DB-9F	RS-232/power (see section 2.1.1.1)

2.1.1 Power Connection

Power is applied via pins 1 and 4 as shown in Figure 2-1. Power requirement for standard units is +5 VDC \pm 0.25V (units with the wide voltage range option require 7 – 15 Vdc). Power may also be supplied via the RS-232 connector.

Warning:

- ~~Do not apply any power with reversed polarization.~~
- ~~Do not apply any voltage other than the specified voltage.~~
- ~~Do not use any cables other than the cables supplied by Matrix Orbital, unless you are aware of the modifications required.~~
- ~~Do not apply power to the DB-9 connector AND the power connector.~~
- ~~Do not apply more than +5Vdc to pin #9 on the DB-9 connector.~~

Connector pinout is as follows:

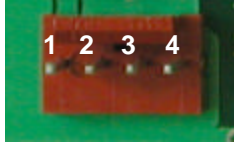

Figure 2-2 Power connector

- Pin 1 +5.0 VDC (+7 to +15 Vdc with wide voltage option)
- Pin 2 SCL (I²C clock) / Tx
- Pin 3 SDA (I²C data) / Rx
- Pin 4 Ground

2.1.1.1 Five Volt Modules

If the LK162-12 is used in a PC it is tempting to plug a spare power connector into the unit. **Don't do this!** Wiring for the PC power connector and that required for the LK162-12 are different as shown in Figure 2-3 below.

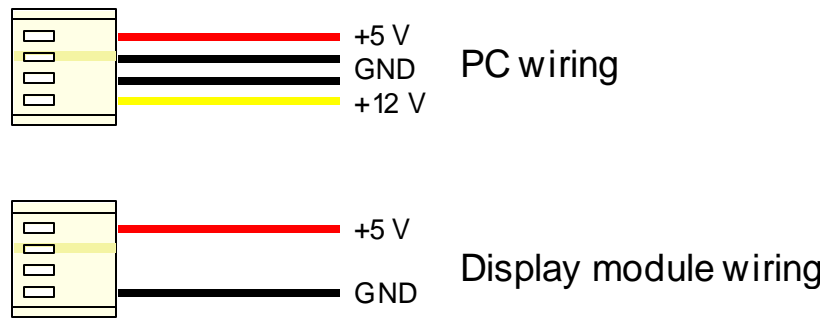

Figure 2-3 Power Connector wiring differences

If you don't want to modify cable wiring yourself, Matrix Orbital can supply an adapter cable designed to use with the LK162-12 when it's installed in a PC. The cable is wired as shown in Figure 2-4 below. Note that this cable does not provide connections for I²C.

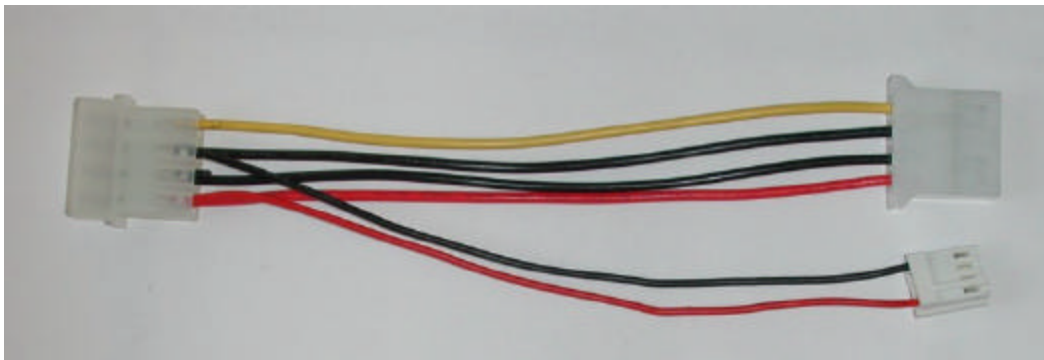

Figure 2-4 Five volt Power Cable

2.1.1.2 Wide Voltage Range Modules

Note: Do not use this cable unless your display module has the "wide voltage range" option (option V). Use of the 12 volt power cable with 5 volt modules will damage the module.

The 12 volt power cable is designed for use with wide voltage range display modules mounted in a PC. Wiring required for the 12 volt power connector is shown in Figure 2-5 below.

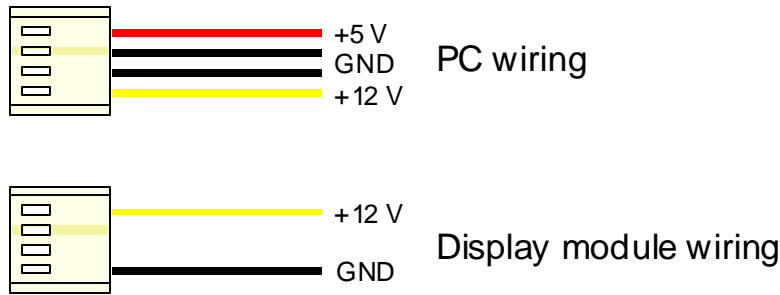

Figure 2-5 Wiring for 12 volt modules

If you don't want to modify cable wiring yourself, Matrix Orbital can supply an adapter cable designed to use with the display module when it's installed in a PC. The cable is wired as shown in Figure 2-6 below.

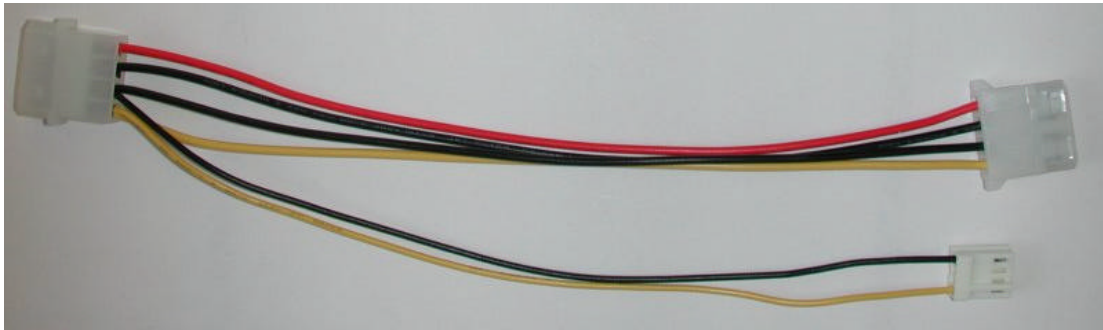
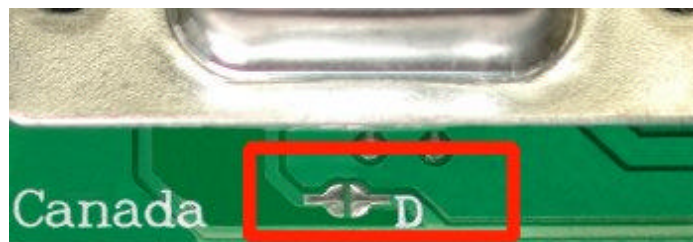

Figure 2-6 Twelve volt power cable

2.1.2 Applying Power through the DB-9 Connector

The LK162-12 can be powered by pin #9 on the DB-9 connector. If power is applied here, power **cannot** be applied to the other power connector. The input voltage for pin #9 can only be +5Vdc, even if the unit is wide voltage. Not following these instructions can destroy the unit.

To use the DB-9 connector for power you will have to solder a jumper as show in the bellow image.



2.1.3 RS-232 Communications

The RS-232 connector on the PC cable is wired so that a standard “straight through” 9 pin D-sub cable may be used to connect the module to a standard serial port such as COM ports on PCs. Note that this device complies with the EIA232 standard in that it uses signal levels from $\pm 12V$ to $\pm 12V$ and can be converted to TTL levels as well. The LCD2041 is set at 19.2Kbps default speed. Other settings are:

8 bits, no parity, 1 stop bit.

2.1.4 DB9 Connection

A standard DB-9F is provided for RS-232 communications. Power may also be supplied via this connector if desired. See Figure 2-7 for pin connections.

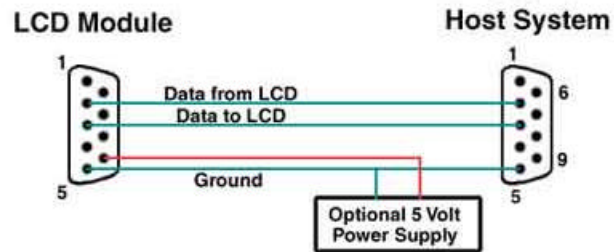
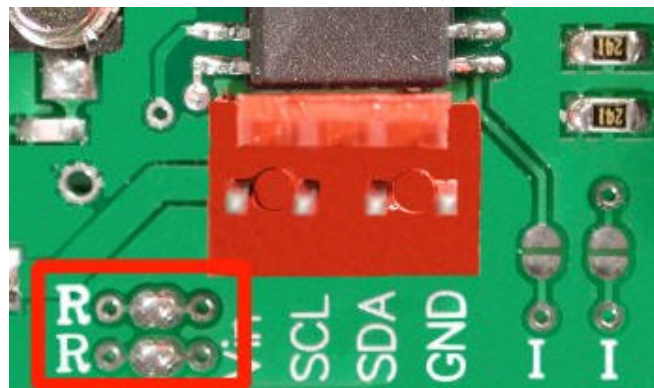

Figure 2-7 RS-232 and power connector

Pin Number	Direction	Description	LCD	Host
2	Data from LCD	Data out (LCD)	Tx	Rx
3	Data to LCD	Data in (LCD)	Rx	Tx
5	-	Ground	gnd	gnd

2.1.5 Alternate Serial Connection

An optional alternate connection header is provided to allow one cable for data and power. Two jumpers will have to be soldered and two removed.



Connector pinout is as follows:

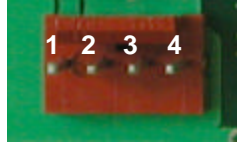

Pin 1	Vdc
Pin 2	Tx
Pin 3	Rx
Pin 4	Ground

2.1.6 TTL Communications

The LCD2041 can be talked to at TTL (logic 0V to +5V) levels. Two modifications have to be made.

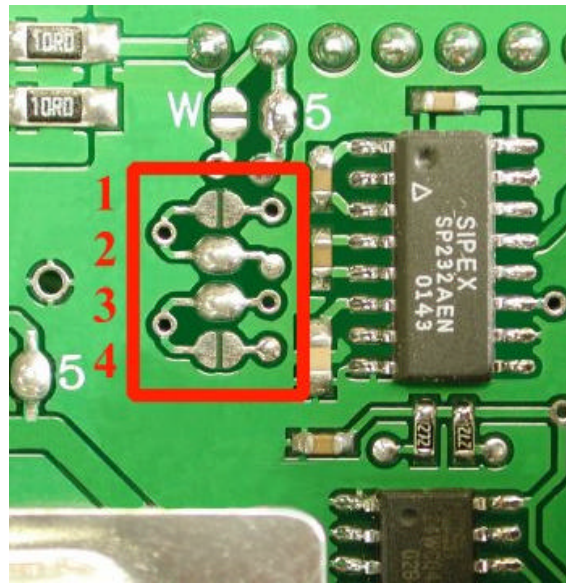

Jumpers 2 and 3 have to be closed and 1 and 4 open.

2.1.7 I²C Communications

I²C communications runs at 100 kbps and supports up to 16 units on a single communications line. The I²C data line operates on 5 volt CMOS levels.

The idea of ACK is to indicate when the data has been received correctly. ACK does not indicate data incorrectly received. ACK simply fails to indicate when data is correctly received. Clearly, this is of limited usefulness and even less so with Matrix Orbital modules. Matrix orbital modules are not capable of failing to acknowledge an incorrectly received byte in response to that bytes transition. They are only capable of failing to acknowledge the bytes following the byte, which was not received. To fully understand the reasons for this one needs to understand something about how a Matrix Orbital module processes data. Basically the reason why a Matrix Orbital module might fail to receive a byte correctly is that it was unable to process the byte previous before the failed byte was transmitted. Because the module cannot possibly know that it would be unable to store the byte before the next byte was received it cannot know to not ACK. The reason for this situation in deference to situations you might be familiar with (i.e. memory chips, etc...) is that the Matrix Orbital module employs a microprocessor to perform these data storage functions. A memory chip takes care of these things entirely with in hardware subsystems that operate at the same speed as the transmission themselves.

The LK404-55 uses a standard Phillips 7bit address as defined by Phillips. How ever, we at Matrix Orbital specify I²C address in 8bits. The 8th bit, least significant bit (LSB or Low Order Bit) of the 8bit address is read/write bit. If we take a standard Phillips 7bit address of 45hex this would be in binary 1000101. This is 7bits. If one adds the read write bit to this 7bit address and you assume that you are writing one gets

10001010. Matrix Orbital would describe the Philips I²C address of 45hex as 8Ahex. The read address would be 8Bhex.

For more information on Phillips I²C please visit...

<http://www.ping.be/~ping0751/i2cfaq/i2cindex.htm>

and for more information specific to our displays visit...

<http://www.lcdforums.com/forums/viewtopic.php?t=910>

To communicate by I²C two jumpers have to be set into the I²C position left of the power SIP connector. The I²C setting is default on the LK162-12.

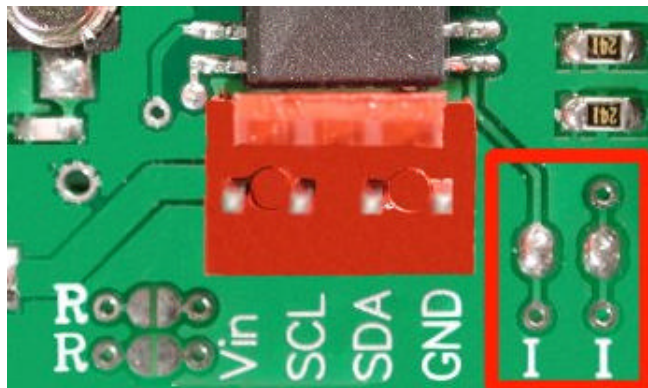

Connector pinout is as follows:



- | | |
|-------|------------------------------|
| Pin 1 | Vdc |
| Pin 2 | SCL (I ² C clock) |
| Pin 3 | SDA (I ² C data) |
| Pin 4 | Ground |

2.2 General Purpose Outputs

The LK162-12 has seven general purpose outputs. These are provided to control relays or other electronic devices. This allows external devices to be turned on or off using your PC or controller and software commands. (See sections 6.1.10 and 6.1.11 for the command syntax.)

Each output is wired as shown in Figure 2-8. The + terminal is connected directly to the module positive supply, the – terminal is connected through a 240 ohm current limiting resistor and the electronic switch to ground.

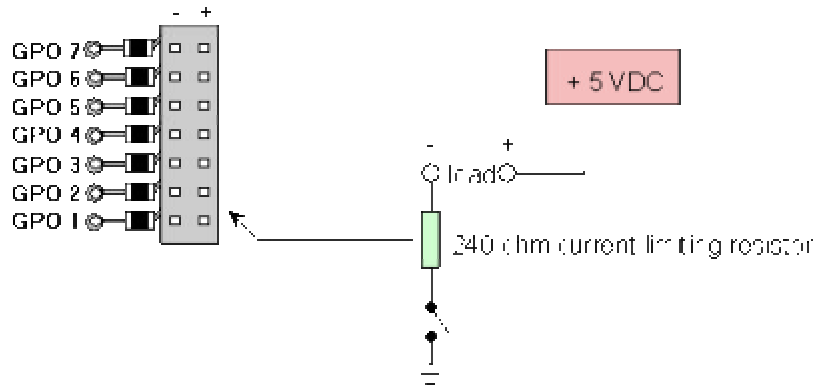

Figure 2-8 General Purpose Outputs

Maximum allowable current is 20mA, which is enforced by the current limiting resistor. If the device being switched has a resistance of 240 ohms or more the corresponding resistor may be shorted.

Note: The GPOs do not have any over current or over/under voltage protection so care must be taken when using them. For instance if the external device is a relay it must be fully clamped (using a diode and capacitor) to absorb any generated back electro-motive force (EMF).

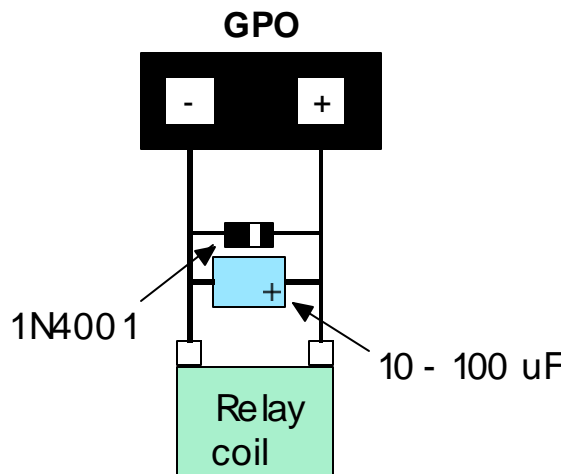

Figure 2-9 Clamping a Relay

3. Displaying Text

This chapter describes the various text-display commands in detail. A quick reference summary of all text commands is found in section 7.4. There is no specific command to display text. Any data sent to the LCD that is not prefixed by the command prefix (0xFE) will be displays on the LCD.

3.1 General

Text is displayed on the LK162-12 using the built-in 5 x 7 dot matrix font (plus up to 8 user-defined characters).

3.2 The Built-In Character Font

The LK162-12 includes a built-in 5 x 7 dot matrix font with the full range of ASCII characters plus a variety of extended characters, as shown in Figure 3-1.

					D7	0	0	0	0	0	0	0	1	1	1	1	1	1	1	1	
					D6	0	0	0	0	1	1	1	1	0	0	0	0	1	1	1	1
					D5	0	0	1	1	0	0	1	1	0	0	1	1	0	0	1	1
					D4	0	1	0	1	0	1	0	1	0	1	0	1	0	1	0	1
D3	D2	D1	D0		0	1	2	3	4	5	6	7	8	9	A	B	C	D	E	F	
0	0	0	0	0				0	0	P	\	P				-	9	E	0	P	
0	0	0	1	1			!	1	0	a	a				.	7	7	4	3	9	
0	0	1	0	2			"	2	R	b	r				"	4	9	x	B	0	
0	0	1	1	3			#	3	C	S	c	e]	0	7	E	E	0	
0	1	0	0	4			\$	4	D	T	d	t			\	I	t	+	H	a	
0	1	0	1	5			%	5	E	U	e	u			.	7	+	1	S	0	
0	1	1	0	6			&	6	F	U	f	u			.	0	1	3	P	Σ	
0	1	1	1	7			'	7	G	U	g	w			.	7	7	7	3	π	
1	0	0	0	8			<	8	H	X	h	x			.	4	0	7	U	r	
1	0	0	1	9			>	9	I	Y	i	y			.	0	7	U	l	y	
1	0	1	0	A			*	:	J	Z	j	z			.	1	0	n	V	J	
1	0	1	1	B			+	;	K	L	k	l			.	7	7	1	0	7	
1	1	0	0	C			,	<	L	Y	l	y			.	7	7	7	7	7	
1	1	0	1	D			-	=	M	I	m	i			.	7	7	7	7	7	
1	1	1	0	E			.	>	N	^	n	^			.	7	7	7	7	7	
1	1	1	1	F			/	?	O	_	o	_			.	7	7	7	7	7	

Figure 3-1 Character Set

In addition to the built-in characters, users may define up to 8 special characters (which, once defined, occupy positions 0x00 to 0x07 in the above chart). The LK162-12 does not have provision to download other fonts.

3.3 Writing Text to the Display

When the display receives a character, it displays that character at the position currently defined. The next character sent to the module then advances to the following position on the display. Characters are drawn using the built-in font, and only characters defined in the font are actually displayed. Characters that are not defined by the built-in font print as a space (i.e. the cursor is advanced for the next character).

The position where text is to be inserted is a character location stored in the LK162-12's volatile memory and maintained internally by the LK162-12's firmware. This position is manipulated by the commands shown in the following section.

3.4 Text Commands

In this section commands are identified by their names and decimal values. Hex and ASCII equivalents are given in the summary (Table 7-1). **Before issuing commands to the LK162-12 please read sections 7.2 and 7.3.**

Some commands, marked with an (R), may be "remembered" to set new defaults that will be in effect each time the unit is powered on. See section 6.1.1 for further information.

3.4.1 Auto line wrap on (254 67) (R)

Enables automatic line wrapping. Note that this is not "word wrapping" and wraps may occur in the middle of a word.

3.4.2 Auto line wrap off (254 68) (R)

Disables automatic line wrapping. Characters beyond the end of a line will be lost.

3.4.3 Auto scroll on (254 81) (R)

When auto scrolling is on, it causes the LK162-12 to shift the entire display's contents up to make room for a new line of text when the text reaches the scroll position (the bottom right character position).

3.4.4 Auto scroll off (254 82) (R)

When auto scrolling is disabled, text will wrap to the top left corner of the display area. Existing text in the display area is not erased before new text is placed. A series of "spaces" followed by a Cursor Home command may be used to erase the top line of text.

3.4.5 Set cursor position (254 71 [column] [row])

This command sets the cursor position (text insertion point) to the [column] and [row] specified. Columns have values from 1 to 20 (0x01 to 0x14) and rows have values of 1 and 2 (0x01 and 0x02).

3.4.6 Send cursor home (254 72)

This command moves the cursor position (text insertion point) to the top left of the display area.

3.4.7 Turn on underline cursor (254 74) (R)

Turns on the underline cursor. The cursor shows the current text insertion point. Both underline and blinking cursors may be turned on or off independently. The cursor is off by default.

3.4.8 Turn off underline cursor (254 75) (R)

Turns off the underline cursor. Does not affect the blinking block cursor.

3.4.9 Turn on block (blinking) cursor (254 83) (R)

Turns on the blinking block cursor. The cursor shows the current text insertion point. Both blinking and underline cursors may be turned on or off independently. The cursor is off by default.

3.4.10 Turn off block (blinking) cursor (254 84) (R)

Turns off the blinking block cursor. Does not affect the underline cursor.

3.4.11 Cursor left (254 76)

Moves the cursor one position to the left but does not erase any character that may be in that position. Note that this command moves the text insertion point even if the cursor is turned off.

Note: A "destructive backspace", which erases the character to the left of the original position, may be done by issuing the following sequence: cursor left, space, cursor left.

3.4.12 Cursor right (254 77)

Moves the cursor one position to the right but does not erase any character that may be in that position. Note that this command moves the text insertion point even if the cursor is turned off.

4. Keypad Interface

This chapter describes the keypad interface and associated commands in detail.

4.1 General

The LK162-12 keypad interface processes the keypad row/column matrix into a serial (RS-232 or I²C) data byte stream. Aside from this processing, the keypad has no effect on the LK162-12 display. If you need to send keystrokes to the display, they must be routed through your controller. Whenever a columns and a row pin are shorted together, a keystroke will be generated and either held in the buffer (I²C) or send over the serial line to the host (RS-232). The keypad shares the same pins as the seven GPOs on the LK162-12 and only one or the other can be used at one time.

4.2 Connections

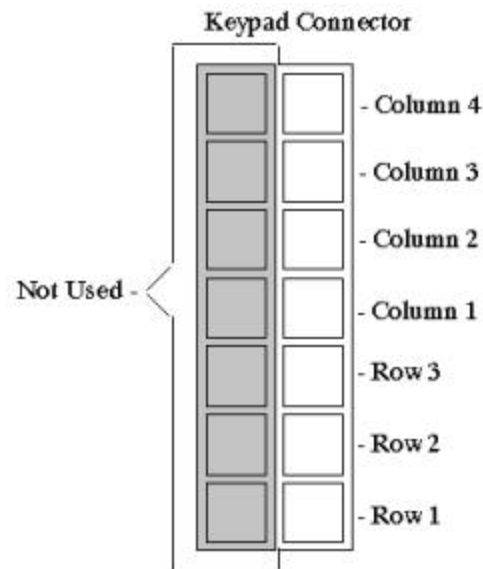

Figure 4-1 Keypad Connector

The connector is not "keyed" so your keypad will probably plug in either of two ways. The LK162-12 will not be damaged by reversing the connector, but your keypad will generate a different ASCII character mapping for each position. If your connector has fewer than 7 pins it should be centered on the LK162-12 connector, starting with Row 3 and Column 1 and going out. Any matrix style keypad will work with the LK162-12, as well, momentary switches.

The returned key codes are as follows, but note that your keypad may be laid out in a different pattern. If this is the case, you will need to interpret the key codes differently. The diagram 1 shows the logical layout (row 1, column 1 in upper left). The connector for the keypad is a 10 pin 0.1" spacing male header. Pin 1 is indicated in Figure 2-1. Pins 1 through 5 are columns and pins 6 through 10 are rows. The keypad is scanned whenever a key is pressed: there is no continuous key scan. This means that key presses are dealt with immediately without any appreciable latency. This also prevents electrical noise which is often caused by continuous key scans.

Rows	Columns			
		1	2	3
1	'A' 41 Hex	'F' 46 Hex	'K' 4B Hex	'P' 50 Hex
2	'B' 42 Hex	'G' 47 Hex	'L' 4C Hex	'Q' 51 Hex
3	'C' 43 Hex	'H' 48 Hex	'M' 4D Hex	'R' 52 Hex

Note: The keypad connector must be wired with columns on one side and rows on the other side of the center of the connector. If your keypad isn't wired this way you will need to make an adapter or rewire the connector to meet this requirement.

4.3 I²C Interface

The keypad is read by I²C master read. In short, this means that a read of the module will always return the first unread key press. A read is initiated by writing to the module with its base address plus 1, then clocking the module's return byte after the module releases the SDA line. Much more detail on this basic I²C function can be found in the I²C specification by Philips. A good reference is also available at

<http://www.ping.be/~ping0751/i2cfaq/i2cindex.htm>

The module contains a ten key press buffer so that it can be polled for key presses at an infrequent rate (every 500 to 1000 mS is typical). All returned key presses indicate the presence or absence of additional logged key presses by the most significant bit (MSB - bit 7). If the user has pressed two keys since the last poll of the keypad interface, the first read will return the key code with bit 7 set and the second read will return the key code with bit 7 clear. The application must take into account this bit to keep up with user key presses. If there are no keypresses detected, the module will return zero (0x00).

4.4 RS-232 Interface

By default on any press of a key, the module will immediately send out the key code at the selected baud rate. This behavior can be modified using commands found in the next section.

4.5 Keypad Commands

Before issuing commands to the LK162-12 please read sections 7.2 and 7.3.

Some commands, marked with an (R), may be "remembered" to set new defaults that will be in effect each time the unit is powered on. See section 6.1.1 for further information.

4.5.1 Auto repeat mode on (254 126 [mode]) (R)

[mode] = 0x00 gives Resend Key Code mode

[mode] = 0x01 gives Key down / Key up code mode

Two Modes of auto repeat are available and are set via the same command.

1. **Resend Key Code:** This mode is similar to the action of a keyboard on a PC. In this mode, when a key is held down, the key code is transmitted immediately followed by a 1/2 second delay. After this delay, key codes will be sent via the RS - 232 interface at a rate of about 5 codes per second. This mode has no effect if polling or if using the I²C interface.
2. **Key down / Key up codes:** This mode may be used when the typematic parameters of the Resend Key code mode are unacceptable or if the unit is being operated in polled mode. The host system detects the press of a key and simulates an auto repeat inside the host system until the key release is detected.

In this mode, when a key is held down, the key code is transmitted immediately and no other codes will be sent until the key is released. On the release of the key, the key release code transmitted will be a value equal to the key down code plus 20 hex. For example, the key code associated with key 'P' (0x50) is pressed, the release code is 'p' (0x70).

In RS-232 polled mode (see 0 below) or via the I²C interface, the key down / key up codes are used; however, the user should be careful of timing details. If the poll rate is slower than the simulated auto-repeat it is possible that polling for a *key up* code will be delayed long enough for an unwanted key repeat to be generated (see Figure 4-2).

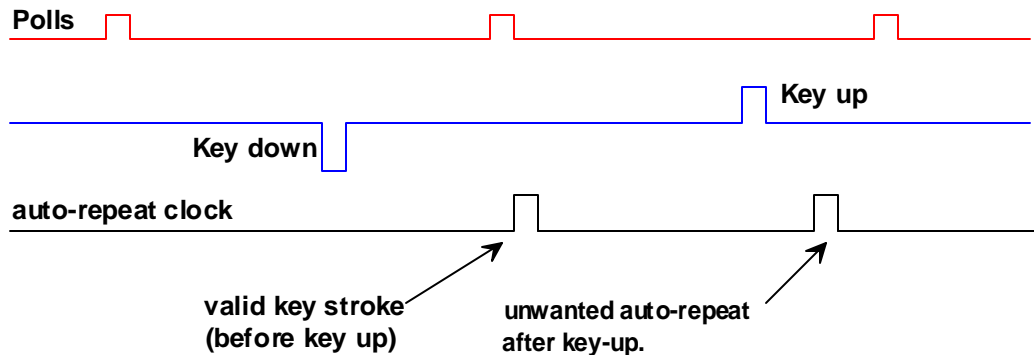

Figure 4-2 Poll timing

4.5.2 Auto repeat mode off (254 96) (R)

This command turns off auto repeat mode.

4.5.3 Auto transmit keypresses on (254 65) (R)

In this mode, all keypresses are sent immediately to the host system without the use of the poll keypad command. This is the default mode on power up.

4.5.4 Auto transmit keypresses off (254 79) (R)

In this mode, up to 10 keypresses are buffered until the unit is polled by the host system via the poll keypad command. Issuing this command places the unit in *polled mode*.

4.5.5 Clear key buffer (254 69)

This command clears any unread keypresses. In a menuing application, if the user presses a key which changes the menu context, any following key presses may be inaccurate and can be cleared out of the buffer

between menu changes to prevent jumping around the menu tree. It may also be used to, in effect, reset the keypad in case the host application resets for whatever reason.

4.5.6 Poll keypad (254 38)

This command returns any unbuffered keypresses via the RS - 232 interface. The host system must be set up to receive the key codes. When the LK162-12 receives this command it will immediately return any unbuffered keypresses which may have not been read already. If there is more than one keypress buffered, then the high order bit (MSB) of this returned keycode will be set (1). If this is the only buffered keypress, then the MSB will be reset (0). If there are no buffered keypresses, then the returned code will be 0x00. Please note to make use of this command the “Auto Transmit Keypress” mode should be off.

4.5.7 Set debounce time (254 85 [time]) (R)

[time] is in increments of 6.554 milliseconds.

This command sets the time between key press and key read. All key types with the exception of latched piezo switches will “bounce” for a varying time, depending on their physical characteristics. The default debounce time for the module is about 52 mS, which is adequate for most membrane keypads. This time equates to a setting of 8 using this command as there is a debounce time resolution of 6.554 milliseconds.

5. Bar Graphs and Special Characters

The LK162-12 includes the ability to draw bar graphs (either horizontal or vertical) and allows users to define up to eight special characters. **Before issuing commands to the LK162-12 please read sections 7.2 and 7.3.**

Eight characters (ASCII values 0x00 to 0x07) are set aside for use with bar graphs, user defined characters, and big numbers. Since the same 8 characters are used for each function, the functions may not be used simultaneously. The characters may be defined or redefined at any time by issuing the commands shown in this section. Once defined, they may be used either by means of the bar graph commands, or by simply issuing one of the ASCII values 0x00 to 0x07 (which is not prefixed by the command byte, 254).

5.1 Command List

5.1.1 Initialize wide vertical bar graph (254 118)

This command defines the 8 special/user characters to be blocks suitable for use in drawing wide (5 pixel) vertical bar graphs. Any previously existing definitions will be lost. Once this command has been issued, any number of vertical bar graphs may be drawn unless the characters are redefined by another command.

5.1.2 Initialize narrow vertical bar graph (154 115)

This command defines the 8 special/user characters to be blocks suitable for use in drawing narrow (2 pixel) vertical bar graphs. Any previously existing definitions will be lost. Once this command has been issued, any number of vertical bar graphs may be drawn unless the characters are redefined by another command.

5.1.3 Draw vertical bar graph (254 61 [column] [height])

Draws a vertical bar graph in [column] having a height of [height] pixels. The height may range from 0 to 20 (0x00 to 0x14) pixels. The necessary characters must first be initialized by either of the commands shown in section 5.1.1 or 5.1.2, which will determine the width of the graph drawn. Graph may be erased by drawing a bar graph of height = 0 in the same column.

5.1.4 Initialize horizontal bar graph (254 104)

This command defines the 8 special/user characters to be blocks suitable for use in drawing horizontal bar graphs. Any previously existing definitions will be lost. Once this command has been issued, any number of horizontal bar graphs may be drawn unless the characters are redefined by another command.

5.1.5 Draw horizontal bar graph (254 124 [column] [row] [dir] [length])

Draws a horizontal bar graph in [row] starting at [column] with a length of [length] pixels. [row] may have a value of 0x01 or 0x02, column may range from 0x01 to 0x14 and length may be from 0x00 to 0x64 (0 to 100) if the graph can extend the full width of the screen. Each column is 5 pixels wide (spaces between the columns don't count).

[dir] specifies the direction: 0x00 goes from left to right, 0x01 goes from right to left.

5.1.6 Define custom character (254 78 [c] [8 bytes])

The LK162-12 allows up to 8 user defined (custom) characters. These characters occupy the first 8 (0x00 to 0x07) places in the character set (see Figure 3-1).

Custom characters occupy a 5 x 8 pixel matrix. Built-in characters are 5 x 7: the bottom row of pixels is normally reserved for the underline cursor. The underline cursor should be turned off if the bottom row of pixels forms part of a custom character.

The characters are defined by issuing the command 254 78 [c] followed by 8 bytes to define the character. [c] is the character number (0x00 to 0x07). The 8 bytes are mapped as shown below:

MSB			LSB					
*	*	*	1	2	3	4	5	Data Byte 1
*	*	*	6	7	8	9	10	Data Byte 2
*	*	*	11	12	13	14	15	Data Byte 3
*	*	*	16	17	18	19	20	Data Byte 4
*	*	*	21	22	23	24	25	Data Byte 5
*	*	*	26	27	28	29	30	Data Byte 6
*	*	*	31	32	33	34	35	Data Byte 7
*	*	*	36	37	38	39	40	Data Byte 8

A "1" bit indicates an on (black) pixel, a "0" bit indicates an off (clear) pixel.

Once defined, a character is displayed simply by issuing a value (0x00 to 0x07) corresponding to the character number. The character will be laid out as follows:

1	2	3	4	5
6	7	8	9	10
11	12	13	14	15
16	17	18	19	20
21	22	23	24	25
26	27	28	29	30
31	32	33	34	35
36	37	38	39	40
Cursor Line				

Note: Custom characters will be erased if any of the "initialize bar graph" commands are issued.

Example of a degree symbol:

```
txUart.sendByte(0xFE); //command prefix
txUart.sendByte('N'); //custom character command
txUart.sendByte(0x00); //custom character value 0-7
txUart.sendByte(12); //8 bytes to create
txUart.sendByte(18); //the custom character
txUart.sendByte(18);
txUart.sendByte(12);
```

```
txUart.sendByte(0);  
txUart.sendByte(0);  
txUart.sendByte(0);  
txUart.sendByte(0);
```

```
txUart.sendByte(0x00); //display custom character 0
```

6. Miscellaneous Commands

The commands listed in this chapter don't readily fit in any of the other categories, or are used in more than one category. **Before issuing commands to the LK162-12 please read sections 7.2 and 7.3.**

Some commands, marked with an (R), may be "remembered" to set new defaults that will be in effect each time the unit is powered on. See section 6.1.1 for further information.

6.1 Command List

6.1.1 Remember

This command allows a number of settings, such as cursor state, backlight, etc. to automatically be stored to non-volatile memory so they become new defaults. The command should only be used when required for two reasons:

1. Writing to non-volatile memory is time consuming and slows down the operation of the display.
2. Non-volatile memory has a "write limit" and may only be changed approximately 100,000 times.

Commands which may be used with the "remember" function are marked with an "R" in the "default" column in the command tables.

The example shows the procedure to set Auto scroll ON as the default condition. Commands are shown in both decimal and hex in this example

Decimal	Hex	Function
254 147 1	FE 93 01	Turn on "remember" function.
254 81	FE 51	Turn on auto scroll. Since "remember" is ON, this setting will be saved in non-volatile memory.
254 147 0	FE 93 00	Turn off "remember" function.

Any number of commands may be entered between the "remember ON" and "remember OFF" commands, and all settings will be memorized.

6.1.2 Clear display (254 88)

This command clears the display and resets the text insertion point to the top left of the screen.

6.1.3 Set contrast (254 80 [contrast])

This command sets the display's contrast to [contrast], where [contrast] is a value between 0x00 and 0xFF (between 0 and 255). Lower values cause "on" elements in the display area to appear lighter, while higher values cause "on" elements to appear darker.

Lighting conditions will affect the actual value used for optimal viewing. Individual LK162-12 modules will also differ slightly from each other in appearance. In addition, values for optimal viewing while the LK162-12 backlight is on may differ from values used when backlight is off.

6.1.4 Set contrast and save (254 145 [contrast])

This command works in exactly the same way as the “Set Contrast” command. The only difference is that it saves the contrast value in the non-volatile memory of the module, whereas the previous command only changes the value until the next power down.

6.1.5 Backlight on (254 66 [minutes]) (R)

This command turns on the backlight for a time of [minutes] minutes. If [minutes] is zero (0), the backlight will remain on indefinitely. Note: the factory default for backlight is on.

6.1.6 Backlight off (254 70) (R)

This command turns the backlight of the LK162-12 off.

6.1.7 Load startup screen (254 64 [32 characters])

This command sets and memorizes the startup screen that will appear each time the LK162-12 is turned on. By default the screen shows:

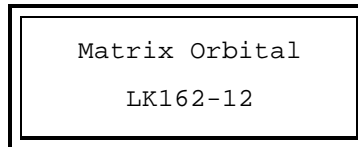

The 40 characters define the two 20 character rows of the screen. They may be any characters from the character set shown in Figure 3-1.

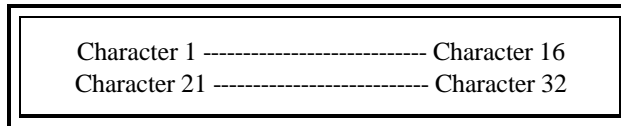

6.1.8 Set backlight brightness (254 153 [brightness])

This command sets the display's brightness to [brightness], where [brightness] is a value between 0x00 and 0xFF (between 0 and 255). The higher the number is, the brighter the backlight will appear.

6.1.9 Set backlight brightness and save (254 154 [brightness])

This command works in exactly the same way as the “Set Backlight Brightness” command. The only difference is that it saves the brightness value in the non-volatile memory of the module, whereas the previous command only changes the value until the next power down.

6.1.10 General purpose output off (254 86 [gpo #])

This command turns OFF any of the General Purpose Outputs (see section 2.2 for a description of the GPOs). [gpo #] is 1 to 7. Note that OFF means that the output floats.

6.1.11 General purpose output on (254 87 [gpo #])

This command turns ON any of the General Purpose Outputs. [gpo #] is 1 to 7. ON means that the output is pulled low (ground via 240 ohms).

6.1.12 Set I²C address 254 51 [address])

This command sets the I²C write address of the module. This value must be an even number and the read address is one higher. For example if the I²C write address is set to 0x50, then the read address is 0x51. The change in address is immediate. This address is 0x50 by default, and is reset temporarily back to that value when the "Manual Over-ride" jumper is used on power up.

6.1.13 Read module type (254 55)

This command will return, over the RS-232 interface, the model type value of the module. Values for various modules at the time of this publication are as follows:

LCD0821 - 0x01	LCD2021 - 0x03	LCD1641 - 0x04
LCD2041 - 0x05	LCD4021 - 0x06	LCD4041 - 0x07
LK202-25 - 0x08	LK204-25 - 0x09	LK404-55 - 0x0A
VFD2021 - 0x0B	VFD2041 - 0x0C	VFD4021 - 0x0D
VK202-25 - 0x0E	VK204-25 - 0x0F	GLC12232 - 0x10
GLC12864 - 0x11	GLC128128 - 0x12	GLC24064 - 0x13
GLK12864-25 - 0x14	GLK24064-25 - 0x15	GLK128128-25 - 0x21
GLK12232-25 - 0x22	LK404-AT - 0x31	VFD1621 - 0x32
LK402-12 - 0x33	LK162-12 - 0x34	LK204-25PC - 0x35

6.1.14 Set RS232 port speed (254 57 [speed])

This command sets the RS232 port to the specified [speed]. The change takes place immediately. [speed] is a single byte specifying the desired port speed. Valid speeds are shown in the table below. The speed can be manually reset to 19,200 baud in the event of an error during transmission (including transmitting a value not listed below) by setting the "manual override" jumper on the module during power. This command is ignored until this jumper is removed again.

Speed Value	Speed
FF Hex	1200 baud
81 Hex	2400 baud
20 Hex	9600 baud
0F Hex	19200 baud

6.1.15 Set Serial Number (254 52 [byte1] [byte2])

Modules may be delivered with the serial number blank. In this case the user may set the desired 2 byte serial number using this **one time only** command.

Upon the execution of this command, the module will echo these two bytes back over the RS-232 interface. The serial number may be set only once. Any future attempt to execute this command will result in no change and the module will return to the originally set serial number.

6.1.16 Read Serial Number (254 53)

This command will return, over the RS-232 interface, the two-byte serial number of the module as it was previously stored.

6.1.17 Read Version Number (254 54)

This command will return the firmware version number of the LK162-12. The firmware version number is a 1-byte hex value.

6.2 Flow Control

The LK162-12 has built-in flow control which may be useful when long strings of text are downloaded to the display. Flow control is enabled or disabled by two commands (see Table 7-4 and the next two sections). If flow control is enabled, the LK162-12 will return an "almost full" message (0xFE) to the controller when its internal buffer fills to a defined level, and an "almost empty" message (0xFF) when the buffer contents drop to a defined level.

6.2.1 Enter Flow Control Mode (254 58 [full][empty])

Note: Flow control applies only to the RS-232 interface. It is not available for I²C.

This command enables flow control. When the buffer fills so that only [full] bytes are available the LK162-12 will return an "almost full" message (0xFE) to the controller. When the buffer empties so that only [empty] bytes remain the LK162-12 will return an "almost empty" message (0xFF) to the controller.

The LK162-12 will return the "almost full" message for every byte sent to the LK162-12 until the used buffer space once more drops below the [full] level.

Whether the user is in 'Flow Control Mode' or not, the module will ignore display or command bytes which would overrun the buffer. While in 'Flow Control Mode' the unit will return 0xFE when buffer is almost full even though it may have already thrown rejected data away. The buffer size for the LK162-12 is 80 bytes.

When using this command in an application, selection of the value for the buffer almost full should be considered very carefully. This is a critical aspect of using this command to it's full potential. When using a host system or PC which contains a FIFO, the user should set the value of [full] equal to or greater than the size of the FIFO. The reason for this is that the FIFO may be full when the host system receives 0xFE. In the case of 16550 UART the size at its maximum is 16, therefore the value of should be set to 16 or greater.

6.2.2 Exit Flow Control Mode (254 59)

This command turns off flow control. Bytes may overflow the buffer without warning.

6.2.3 GPO or Keypad Mode (254 37 [mode])

The LK162-12 shares GPO and keypad pins, you can use one of the other but not both at the same time. To select either General Purpose Outputs or the Keypad Interface on the general purpose output/ keypad connector, send a command prefix followed by the character '%' followed by , where is either 0 or 1 (8 bit binary).

- 0 = Keypad Interface Mode
- 1 = General Purpose Output Mode.

7. Appendix: Command Summary

7.1 General

The operation of the LK162-12 is controlled by a simple and consistent command set. Commands control

- ~~///~~ text display
- ~~///~~ graphics display
- ~~///~~ keypad interface
- ~~///~~ miscellaneous operating parameters

This chapter includes summary tables of all commands. Individual commands are discussed in detail in Chapters 3 to 5 in the same sequence as in the following tables.

7.2 Issuing Commands

Commands are issued to the LK162-12 by the controller. In a test setup, commands can be issued to the LK162-12 by means of a BASIC program, using the chr\$() function. In the tables below, we've shown commands in hex, ASCII and decimal form. All commands begin with the prefix character 0xFE (254 decimal). These commands are issued on the serial communications link (I²C or RS-232) at the currently defined baud rate.

For example (using BASIC in a test setup), you could issue the command to clear the screen on the LK162-12 by including the line:

```
PRINT#1,chr$(254);chr$(88)
```

in your BASIC program.

Or with C you could (using Zcomm serial library)

```
ZComm1->WriteCommByte(0xfe);  
ZComm1->WriteCommByte('X');
```

7.3 On Numbers

Like all computerized devices, the LK162-12 operates with commands and values in the form of binary numbers. These binary numbers are arranged in 8 digit (i.e. 8 bit) groups called bytes. The decimal value of a byte may have any value from 0 to 255.

Bytes are usually specified in either decimal or hexadecimal (base 16) form for convenience, since binary numbers are confusing to deal with directly. Hexadecimal (hex) numbers are particularly convenient because exactly two hexadecimal digits make up one byte, each hex digit representing 4 binary digits (4 bits) as shown here:

Binary	Hex	Decimal	Binary	Hex	Decimal
0000	0	0	1000	8	8
0001	1	1	1001	9	9
0010	2	2	1010	A	10
0011	3	3	1011	B	11
0100	4	4	1100	C	12

0101	5	5	1101	D	13
0110	6	6	1110	E	14
0111	7	7	1111	F	15

Based on the table, the byte 01001011 can be represented in hex as 4B, which is usually written as any of 4Bh, 4BH, 4B hex or 0x4B.

The numbers can also be expressed in decimal form if preferred.

7.3.1 ASCII Characters

Since computers deal internally with numbers only, but externally with both letters and numbers, several schemes were developed to "map" written characters to numeric values. One such scheme has become universal, the American Standard Code for Information Interchange, or ASCII. ASCII tables are readily available from a number of sources. A few examples will do here:

The letter	A	has a value of	65 decimal or	41 hex
The letter	a	has a value of	97 decimal or	61 hex
The number	0	has a value of	48 decimal or	30 hex
The number	9	has a value of	57 decimal or	39 hex

This gives rise to the possibility of confusion when parameters are being set on the LK162-12. For example, the GPO ON and OFF commands use a number to indicate which GPO is being controlled. We're told that acceptable values are 0 to 6. **All such parameters must use numeric values (i.e. the actual byte values).** If we send the ASCII number 0 by mistake it will actually give the value 48 decimal (30 hex) to the parameter, which is wrong.

In the tables given in the following sections ASCII characters are shown as 'A', with single quotes.

7.4 Text Commands

See Chapter 3 for command descriptions. Syntax in the tables below is given in hex, decimal and decimal with ASCII, in that order, one per line.

Note: The letter "R" in the Default column indicates that this state can be saved to nonvolatile memory with the Remember command. See section 6.1.1.

Table 7-1 Text Commands

Command	Syntax	Default	Notes
Auto line wrap on	FE 43 254 67 254 'C'	on R	Enables line wrapping (not word wrap).
Auto line wrap off	FE 44 254 68 254 'D'	on R	Disables line wrapping.
Auto scroll on	FE 51 254 81 254 'Q'	off R	Enables scroll at bottom of screen. Text will push display up one line to make room for new line.

Auto scroll off	FE 52 254 82 254 'R'	off R	Disables auto scroll. Text will wrap to top left and overwrite existing text.
Set cursor position	FE 47 [col] [row] 254 71 [col] [row] 254 'G' [col] [row]	n/a	Moves cursor to the specified column and row. The cursor marks the text insertion point in this and all commands.
Send cursor home	FE 48 254 72 254 'H'		This command moves the cursor to the top left of the display area.
Underline cursor on	FE 4A 254 74 254 'J'	off R	Turns on the underline cursor.
Underline cursor off	FE 4B 254 75 254 'K'	R	Turns off the underline cursor.
Block cursor on	FE 53 254 83 254 'S'	on R	Turns on the blinking block cursor.
Block cursor off	FE 54 254 84 254 'T'	R	Turns off the blinking block cursor.
Cursor left	FE 4C 254 76 254 'L'		Moves the cursor one position to the left. If the cursor is already at the beginning of a line it will move to the end of the other line.
Cursor right	FE 4D 254 77 254 'M'		Moves the cursor one position to the right. If the cursor is already at the end of a line it will move to the beginning of the other line.

7.5 Keypad Interface Commands

Note: The letter "R" in the Default column indicates that this state can be saved to nonvolatile memory with the Remember command.

Table 7-2 Keypad Interface Commands

Command	Syntax	Default	Notes
Auto repeat mode on	FE 7E [0x00 0x01] 254 126 [0 1] 254 '~' [0 1]	off R	Applies to keypad only. 0x00 = 200 ms typematic, 0x01 = key down/key up codes sent.
Auto repeat mode off	FE 60 254 96 254 ''	off R	Applies to keypad only.
Auto transmit key presses on	FE 41 254 65	on R	Sets auto transmit mode for keypad. Key presses are transmitted to host without polling.

Command	Syntax	Default	Notes
	254 'A'		

Auto transmit key presses off	FE 4F 254 79 254 'O'	off R	Up to 10 key presses buffered until polled.
Clear key buffer	FE 45 254 69 254 'E'	n/a	Clear unread key presses.
Poll keypad	FE 26 254 38 254 '&'	n/a	Returns buffered key presses to application. Returns 0x00 if no key presses. High order bit set unless this is the last/only key press.
Set debounce time	FE 55 [time] 254 85 [time] 254 'U' [time]	52 ms R	Resolution: 1 = 0.6554 ms [time] is a numeric multiplier.

7.6 Bar Graphs and Special Characters

The commands in this section are used to define and display bar graphs and special characters.

Table 7-3 Bar Graph and Special Character Commands

Command	Syntax	Notes
Initialize thick vertical bar graph	FE 76 254 118 254 'v'	Initializes the user character set to make wide vertical bar graphs.
Initialize thin vertical bar graph	FE 73 254 115 254 's'	Initializes the user character set to make narrow vertical bar graphs.
Initialize horizontal bar graph	FE 68 254 104 254 'h'	Initializes the user character set to make horizontal bar graphs.
Define custom character	FE 4E [c][8 bytes] 254 78 [c][8 bytes] 254 'N' [c][8 bytes]	Defines one of 8 custom "user" characters. Character number is [c] between 0x00 and 0x07. The 8 bytes are described in section 5.1.6.
Draw vertical bar graph	FE 3D [col][length] 254 61 [col][length] 254 '=' [col][length]	Draws a vertical bar graph at column [col] of length [length]. Length is measured in pixels (0x00 to 0x14). User must first use the 'v' or 's' command to initialize characters.
Draw horizontal bar graph	FE 7C [c][r][d][length] 254 124 [c][r][d][length] 254 ' ' [c][r][d][length]	Draws a horizontal bar graph starting at column [c] on row [r] with direction [d] (0 is right, 1 is left) of length [length]. Length is measured in pixels (0x00 to 0x64 if starting in column 1). User must first use the 'h' command to initialize characters.

7.7 Miscellaneous Commands

Note: The letter "R" in the Default column indicates that this state can be saved to nonvolatile memory with the Remember command.

Table 7-4 Miscellaneous Commands

Command	Syntax	Default	Notes
Remember	FE 93 [0 1] 254 147	off	Turns the "remember" function on [1] or off [0].
Clear display	FE 58 254 88 254 'X'	n/a	Clears screen of text and graphics, places text cursor at top left.
Set contrast	FE 50 [contrast] 254 80 [contrast] 254 'P' [contrast]	0x80 128	Sets display contrast. Compensates for viewing angle. Contrast is a value between 0 and 255 (hex 0 to FF). Larger = darker.
Set contrast and save	FE 91 [contrast] 254 145 [contrast]	0x80 128	Same as "set contrast" but saves [contrast] as default.
Backlight on	FE 42 [minutes] 254 66 [minutes] 254 'B' [minutes]	on R	Backlight will stay on for [minutes]. If [minutes] = 0 backlight will stay on permanently.
Backlight off	FE 46 254 70 254 'F'	on R	Turns off backlight.
Set Brightness	FE 99 [brightness] 254 153 [brightness]	0xFF 255	Sets display brightness. Brightness is a value between 0 and 255 (hex 0 to FF). Larger = brighter.
Set Brightness and save	FE 98 [brightness] 254 152 [brightness]	0xFF 255	Same as "set brightness " but saves [brightness] into memory.
Load startup screen	FE 40 [32 char] 254 64 [32 char] 254 '@' [32 char]	Matrix Orbital LK162-12	Loads new startup screen (32 characters). Screen is remembered for subsequent power ups.
GPO or Keypad Interface Mode	FE 25 [mode] 254 37 [mode] 254 % [mode]	0	To select either GPO or Keypad mode. 0 = Keypad Interface Mode 1 = GPO mode
General purpose output off	FE 56 [gpo #] 254 86 [gpo #] 254 'V' [gpo #]	off	Turns a general purpose output OFF. [gpo #] may be from 1 to 7. See section 2.2 for further details.
General purpose output on	FE 57 [gpo #] 254 87 [gpo #] 254 'W' [gpo #]	off	Turns a general purpose output ON. [gpo #] may be from 1 to 7. See section 2.2 for further details.
Set I ² C address	FE 33 [address] 254 51 [address] 254 '3' [address]	0x50	Value is write address and must be even, read address is 1 higher.

Command	Syntax	Default	Notes
Read module type	FE 37 254 55 254 '7'	see table	Reads the module type. See table in section 6.1.13.
Set RS232 port speed	FE 39 [speed] 254 57 [speed] 254 '9' [speed]	19,200 baud	Sets RS232 speed. See table in section 6.1.14 for values of [speed]
Set Serial Number	FE 34 [byte1][byte2] 254 52 [byte1][byte2] 254 '4' [byte1][byte2]		This is a one-time-use command which works only on units without factory set serial numbers.
Read Serial Number	FE 35 254 53 254 '5'	FF FF	Reads the two byte serial number of the module.
Read Version Number	FE 36 254 54 254 '6'		Reads the firmware version number of the module.
Enter flow control mode	FE 3A [full] [empty] 254 58 [full] [empty] 254 ':' [full] [empty]	off	Sets "full" and "empty" marks for the 80 byte display buffer. When buffer reaches [full] display will return 0xFE to host. When buffer reaches [empty] display will return 0xFF.
Exit flow control mode	FE 3B 254 59 254 ';'		Turns off flow control.

8. Appendix: Specifications and Options

8.1 Specifications

Environmental Specifications		
	Standard Temperature	Extended Temperature
Operating Temperature	0°C to +50°C	-20°C to +70°C
Storage Temperature	-20°C to +70°C	-40°C to +85°C
Operating Relative Humidity	90% max non-condensing	90% max non-condensing

Electrical Specifications	
Supply Voltage	4.75 - 5.25 Vdc 7 - 15 Vdc
Supply Current	9 mA typical
Supply Backlight Current	115 mA typical

Optical Characteristics	
Number of Characters	32 (16 characters by 2 lines)
Matrix format	5 x 7 with underline
Display Area	62.5 x 16.10 mm XxY
Character Size	3.20 x 5.55 mm (XxY), not including underline
Character Pitch	3.7 mm
Line pitch	6.09 mm
Dot Size	0.50 x 0.55 mm (XxY)
Dot Pitch	0.57 x 0.62 mm (XxY)
LED Backlight Life	100,000 hours typical
Color of Illumination	Yellow Green Inverse Blue Gray/White Inverse Yellow

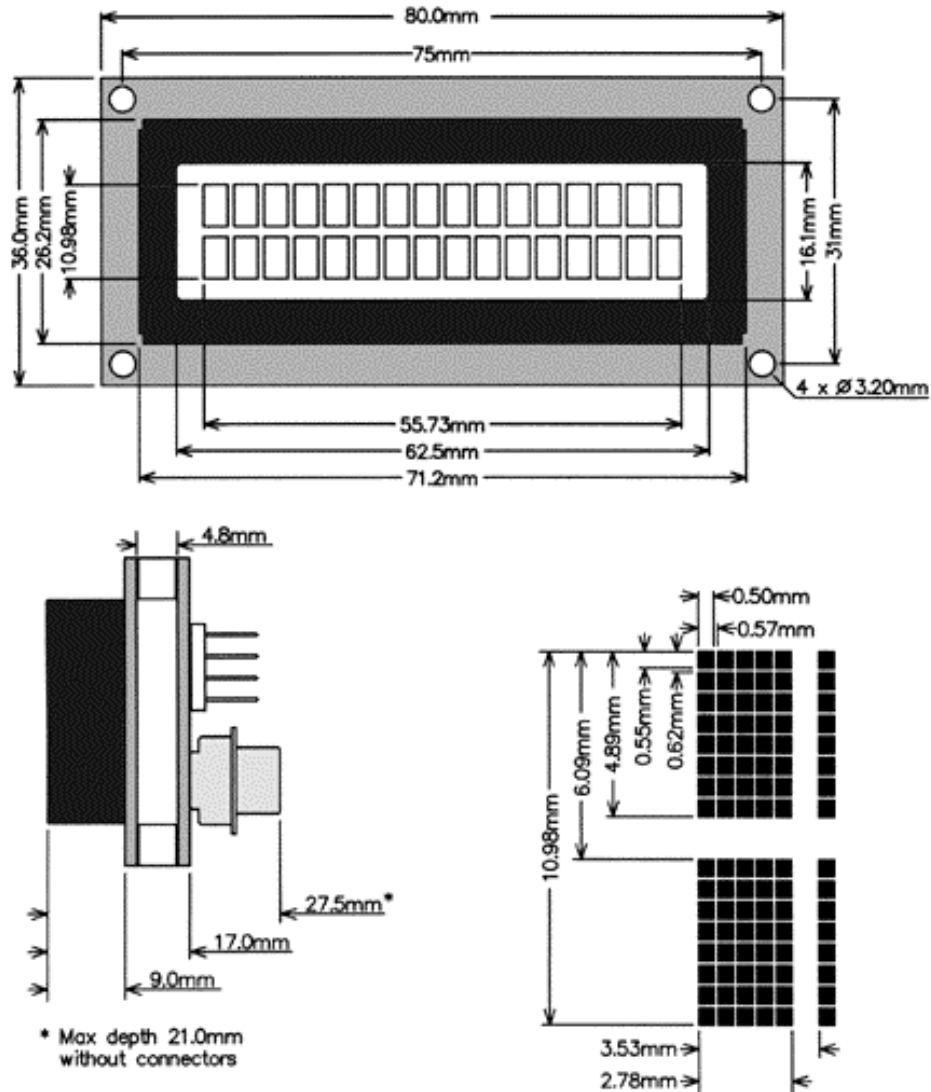

Figure 8-1 Physical Layout

8.2 Options

Options Available on LK162-12	
Extended Temperature	E
Wide Voltage	V
Inverse Yellow; Black backlight with yellow text	IY
Inverse Blue; Blue backlight with white text	WB
White backlight with gray glass (Ice blue look)	GW

9. Appendix: Glossary

ASCII	American Standard Code for Information Interchange. A 7 bit binary code representing the english alphabet, decimal numbers and common punctuation marks. "Also includes control characters" such as carriage return or end of text. An 8 bit superset of the standard ASCII codes is often used today to include foreign characters and other symbols. These supersets are often called extended ASCII character sets.
Backlight	A backlit display is illuminated from behind to provide nighttime and improved daytime readability.
Baud Rate	The (data and signaling) bit transmission rate of an RS232 device.
Binary Number	A number written using binary notation which only uses zeros and ones
Bit	The smallest unit of information a computer can work with. Each bit is either 0 or 1. Binary digit.
Bitmap	A representation, consisting of rows and columns of dots, of a graphics image in computer memory. The value of each dot (whether it is filled in or not) is stored in one or more bits of data.
Byte	A grouping of eight binary bits
CCFL	Cold Cathode Fluorescent Lamp. A high brightness backlighting source consists of a fluorescent tube powered by a high voltage A.C. source.
Configuration	The way a system is set up, or the assortment of components that make up the system. Configuration can refer to either hardware or software, or the combination of both.
Contrast	The ratio of luminance between the light state of the display to the dark state of the display.
Controller	The microcontroller or PC used to control the Matrix Orbital display unit.
DB-9	The designation of a connector used in the RS232 interface: 9 pin connector
Firmware	Software (programs or data) that has been written onto read-only memory (ROM). Firmware is a combination of software and hardware. ROMs, PROMs and EPROMs and flash EEPROMs that have data or programs recorded on them are firmware.
Font	A design for a set of characters. A font is the combination of typeface and other qualities, such as size, pitch, and spacing.
Font Metric	A definition of where font is to be placed, such as margins and spacing between characters and lines.
Hexadecimal	Refers to the base-16 number system, which consists of 16 unique symbols: the numbers 0 to 9 and the letters A to F. For example, the decimal number 15 is represented as F in the hexadecimal numbering system. The hexadecimal system is useful because it can represent every byte (8 bits) as two consecutive hexadecimal digits. It is easier for humans to read hexadecimal numbers than binary numbers.
I²C	Short for Inter-IC, a type of bus designed by Philips Semiconductors in the early 1980s, which is used to connect integrated circuits (ICs). I ² C is a multi-master bus. which means that multiple chips can be connected to the same

	bus and each one can act as a master by initiating a data transfer.
Interface	A means by which two systems interact.
LCD	Liquid Crystal Display
Module Type Value	This refers to the model number of the module.
Pixel	The smallest individually controllable element of a display.
Pre-Generated Fonts	Pre-determined fonts which can be downloaded into graphic liquid crystal displays.
Primitive	A low-level object or operation from which higher-level, more complex objects and operations can be constructed. In graphics, primitives are basic elements, such as lines, curves, and polygons, which you can combine to create more complex graphical images
RS-232	Short for recommended standard-232C, a standard interface approved by the Electronic Industries Association (EIA) for connecting serial devices.
Scroll	To view consecutive lines of data on the display screen. The term scroll means that once the screen is full, each new line appears at the bottom edge of the screen and all other lines move up one position.
Serial Number	A number that is one of a series and is used for identification of the module
Serial Port	A port, or interface, that can be used for serial communication, in which only 1 bit is transmitted at a time.
Version Number	This refers to the firmware revision number of the module.
Volatile Memory	Temporary memory. Once the power supply is turned off volatile memory is then erased.